



Slider M35 • Slider M50

SALICE

Slider M35 - M50



M35 e **M50** são sistemas coplanares para vãos de média dimensão com portas de peso máximo de 35 e 50 kg.

Graças às patentes exclusivas da série Slider e ao revolucionário amortecedor magnético, o deslizamento é intuitivo, fluido e silencioso.

M35 está disponível também na versão motorizada Power, que é dotada de uma parte inferior projetada para permitir a montagem dos suportes típicos da cozinha. Por sua vez, o **M50** destaca-se pela versatilidade: adaptável aos mais diversos tipos de ambientes, pode ser utilizado com as portas distantes 17 ou 33 mm do piso.



Devido às suas características, o **M35** é destinado principalmente para o uso em cozinha, enquanto o **M50** é ideal para os armários de quarto, móveis de escritório e instalações comerciais.





Slider M35

Slider M35



Informações técnicas

Sistema deslizante coplanar com duas portas com amortecedor magnético. Devido às suas características, o **M35** é destinado principalmente para o uso em cozinha.

Características das portas:

- peso máximo por porta:
 - 35 Kg
- largura:
 - mínimo 600 mm máximo 2000 mm
- altura:
 - mínimo 1200 mm máximo 2200 mm

• espessura:

- com grupo de regulagem superior embutido mínimo 18 mm, máximo com puxador 45 mm
- com grupo de regulagem superior externo mínimo 18 mm, máximo com puxador 40 mm

• material: madeira

- pode ser utilizado em porta com quadro de alumínio Clipper

Regulagem da porta:

- vertical ± 5 mm
- horizontal ± 3.5 mm
- frontal: - superior ± 3 mm
- inferior ± 3 mm

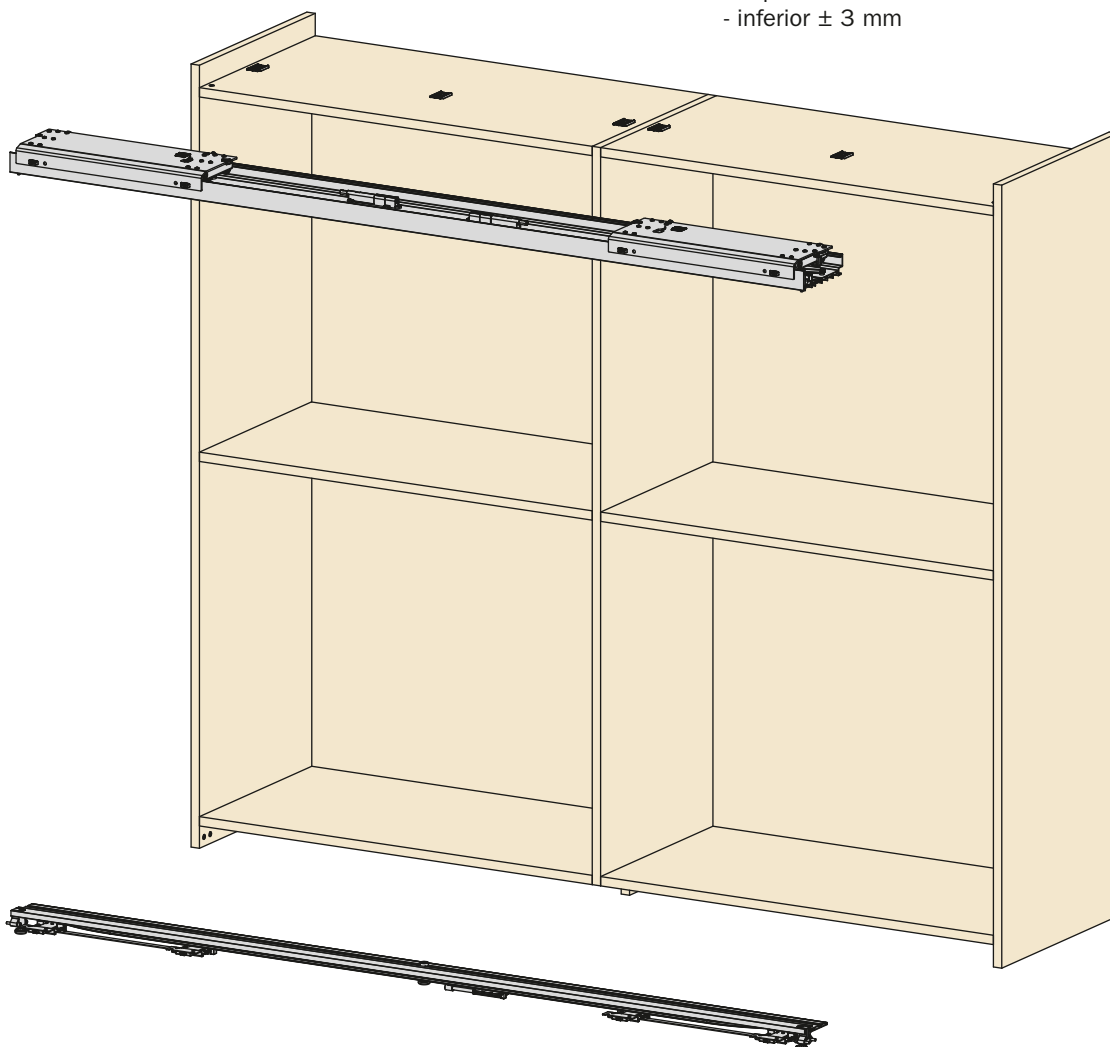

Principais características

- Amortecedor com tecnologia magnética.
- Máxima simplicidade de montagem.
- Absoluta fluidez no deslizamento com amortecedor na abertura e no fechamento.
- Elevada confiabilidade, comprovada com teste de 100.000 ciclos.

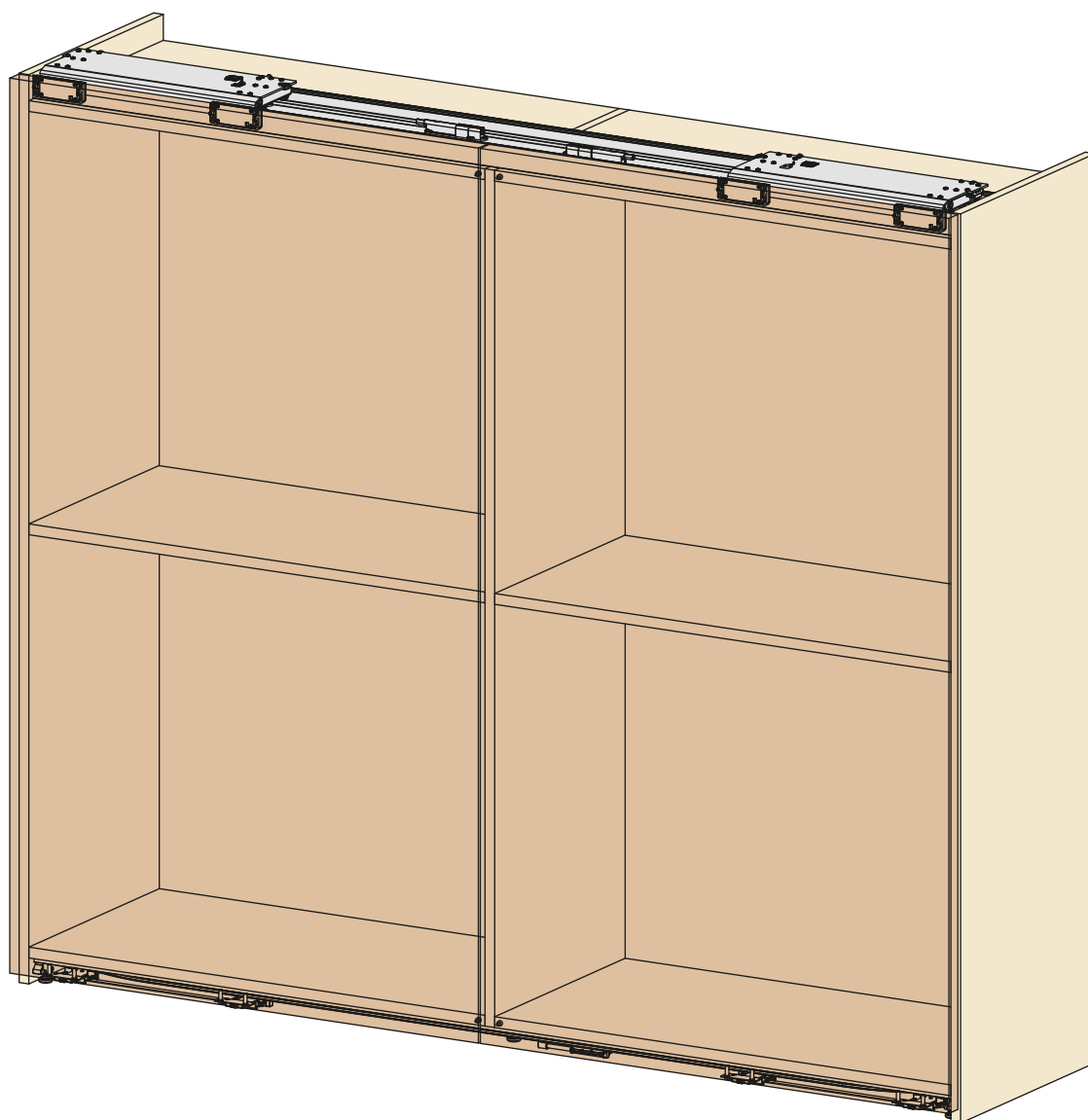

Slider M35 - Tipos de montagem

A27

Grupos de regulagens externos

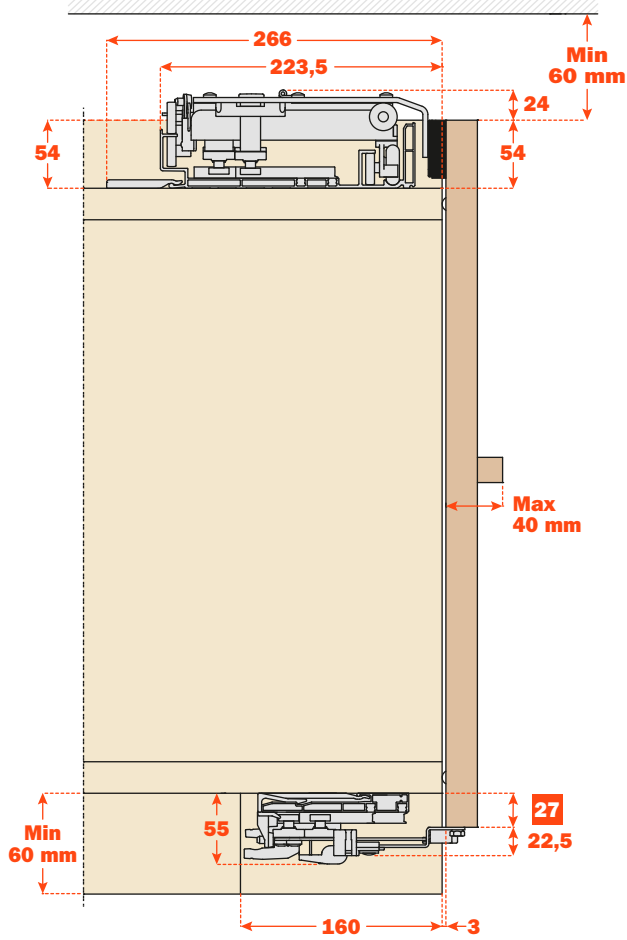

A27

Grupos de regulagens embutidos

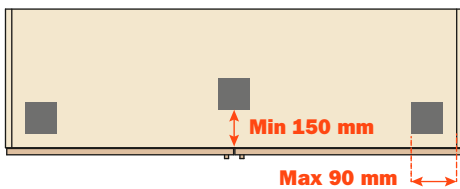
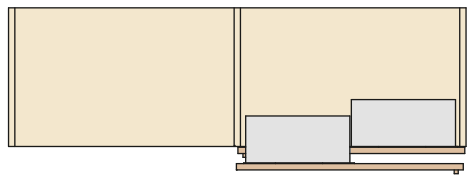
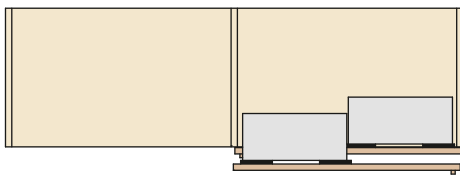
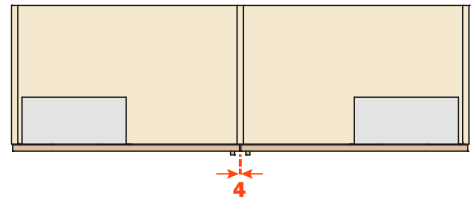
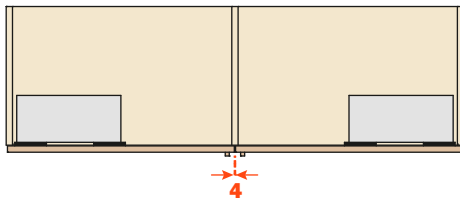
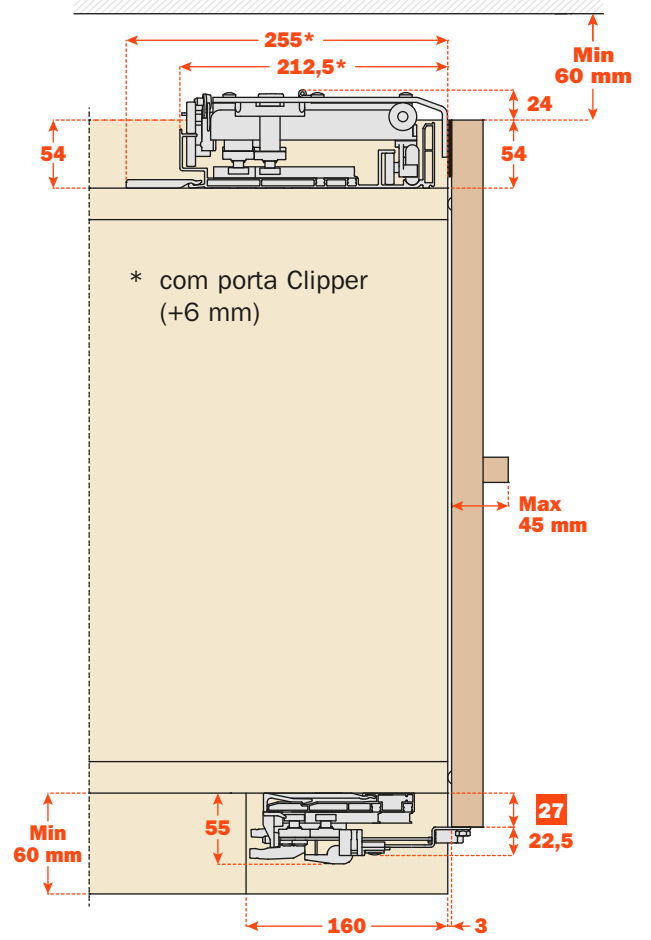

■ Pé nivelador

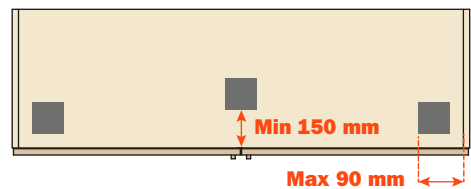

A43

Grupos de regulagens externos

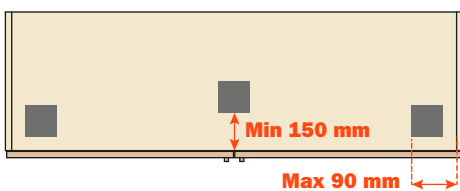
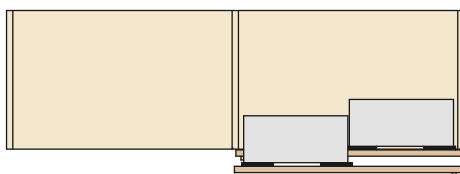
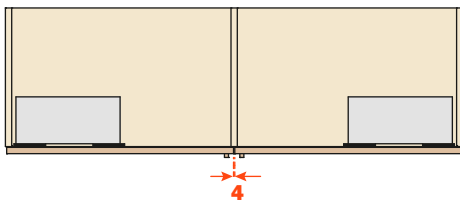
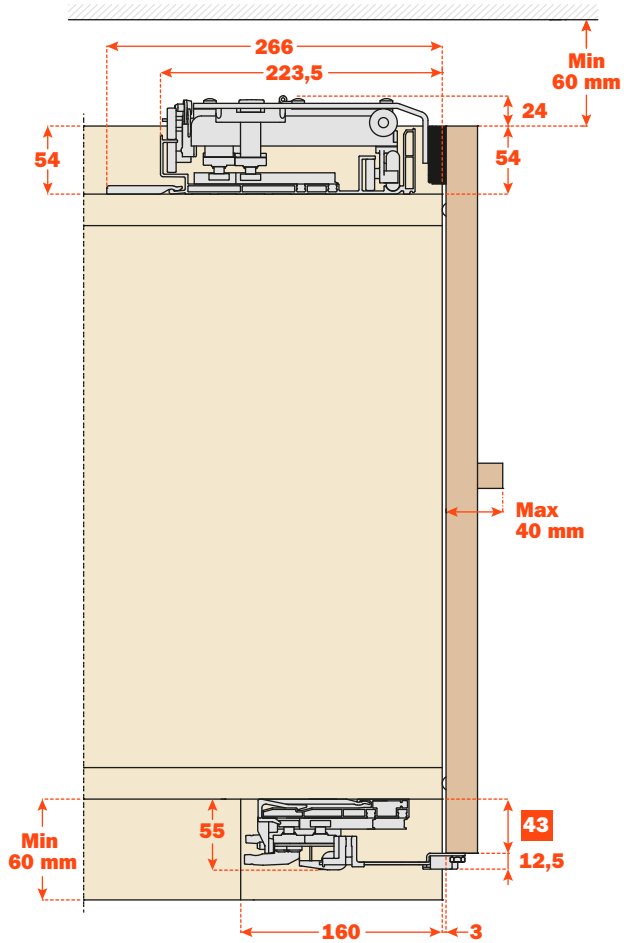

A43

Grupos de regulagens embutidos

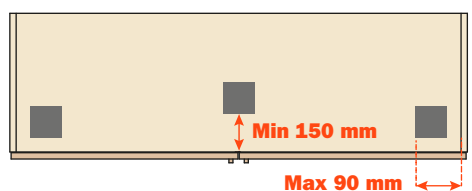
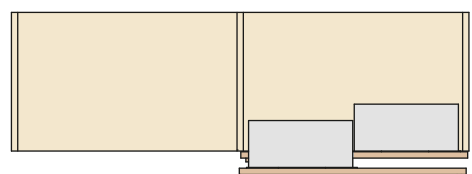
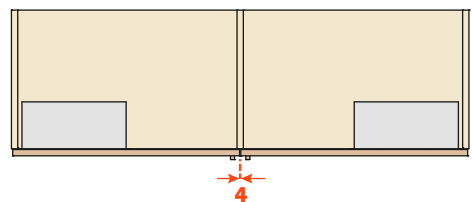
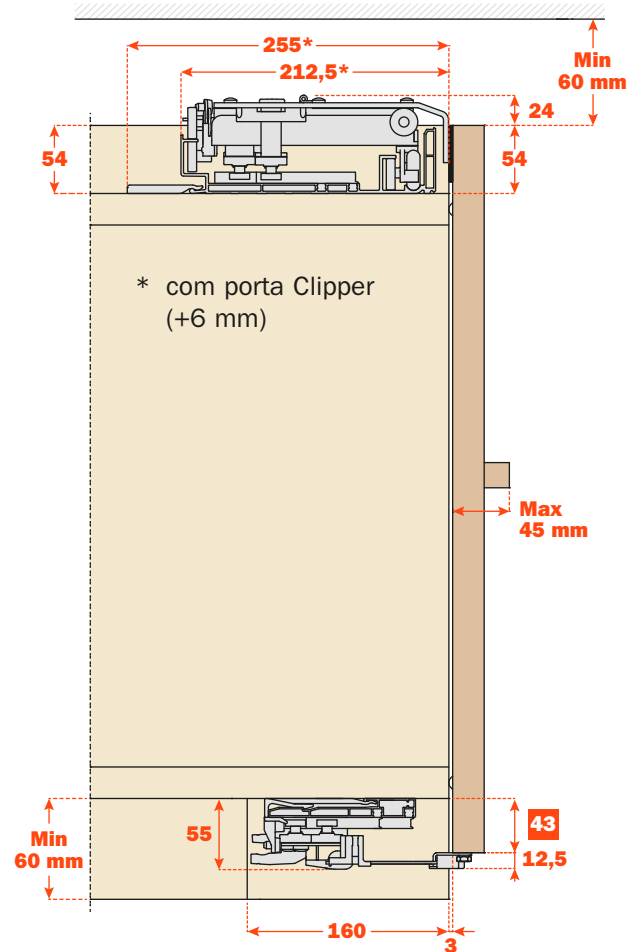

■ Pé nivelador

Slider M35 - Tipos de montagem

B27

Grupos de regulagens externos

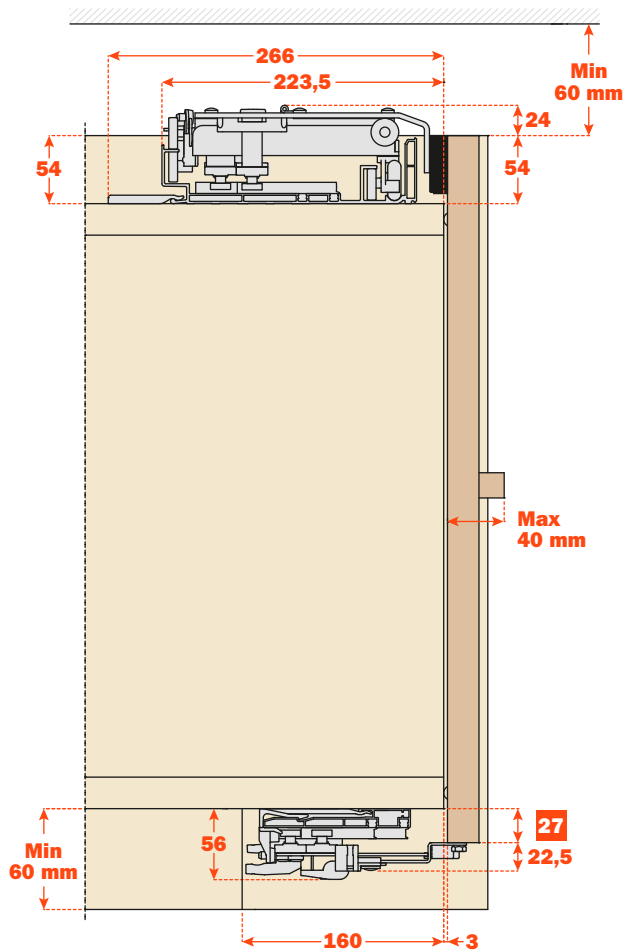

B27

Grupos de regulagens embutidos

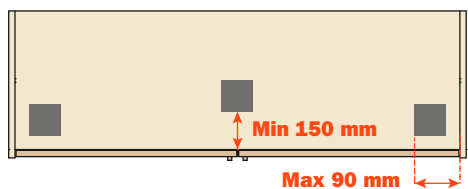
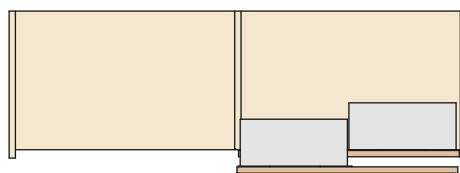
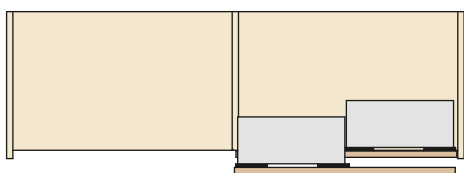
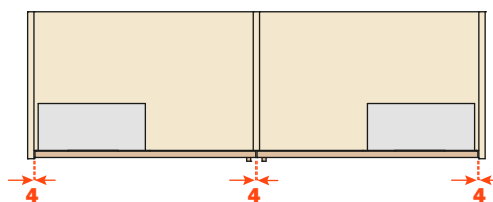
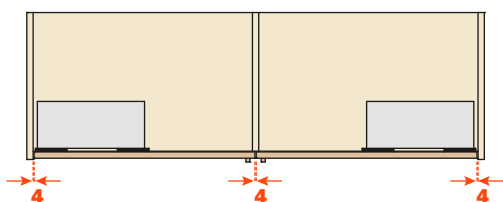
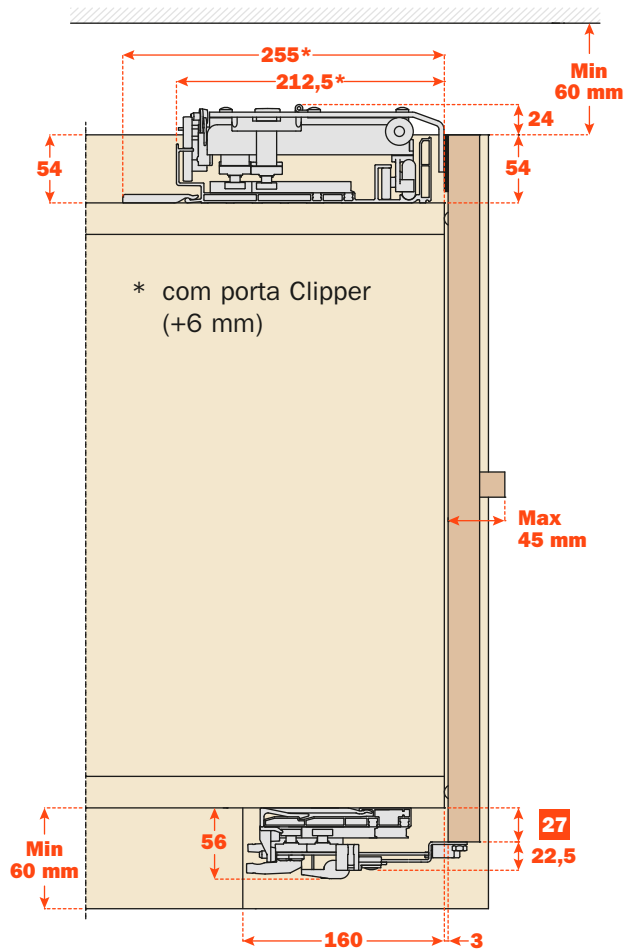

■ Pé nivelador

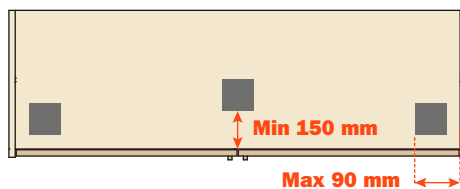

Slider M35 - Como pedir

Sob medida

Os mecanismos Slider M35 podem ser solicitados “sob medida”, ou seja projetados para serem instalados em móveis com largura interna (**LI**) igual ao comprimento dos trilhos (**CP**).

Atenção: a abertura das portas pode ser decidida pelo cliente graças à variável **RAA** (distância entre a lateral central e a borda da porta).

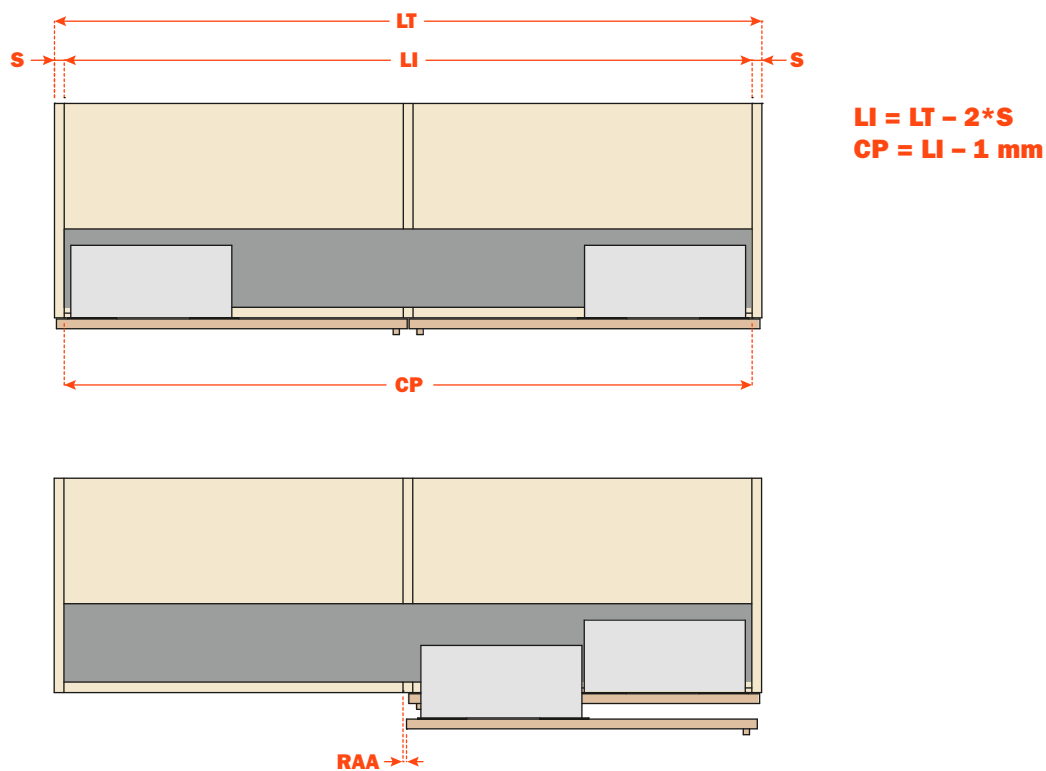



Slider M50

Slider M50



Informações técnicas

Sistema deslizante coplanar com duas portas com amortecedor magnético.

Devido às suas características **M50** é ideal para os armários de quarto, móveis de escritório e instalações comerciais.

Características das portas:

- peso máximo por porta: 50 Kg
- largura: mínimo 800 mm máximo 2000 mm
- altura: mínimo 1200 mm máximo 3000 mm

• espessura:

- com grupo de regulação superior embutido mínimo 18 mm, máximo com puxador 45 mm
- com grupo de regulação superior externo mínimo 18 mm, máximo com puxador 40 mm

• material: madeira

- pode ser utilizado em porta com quadro de alumínio Clipper

Regulagem da porta:

- vertical ± 5 mm
- horizontal ± 3.5 mm
- frontal: - superior ± 3 mm
- inferior ± 3 mm

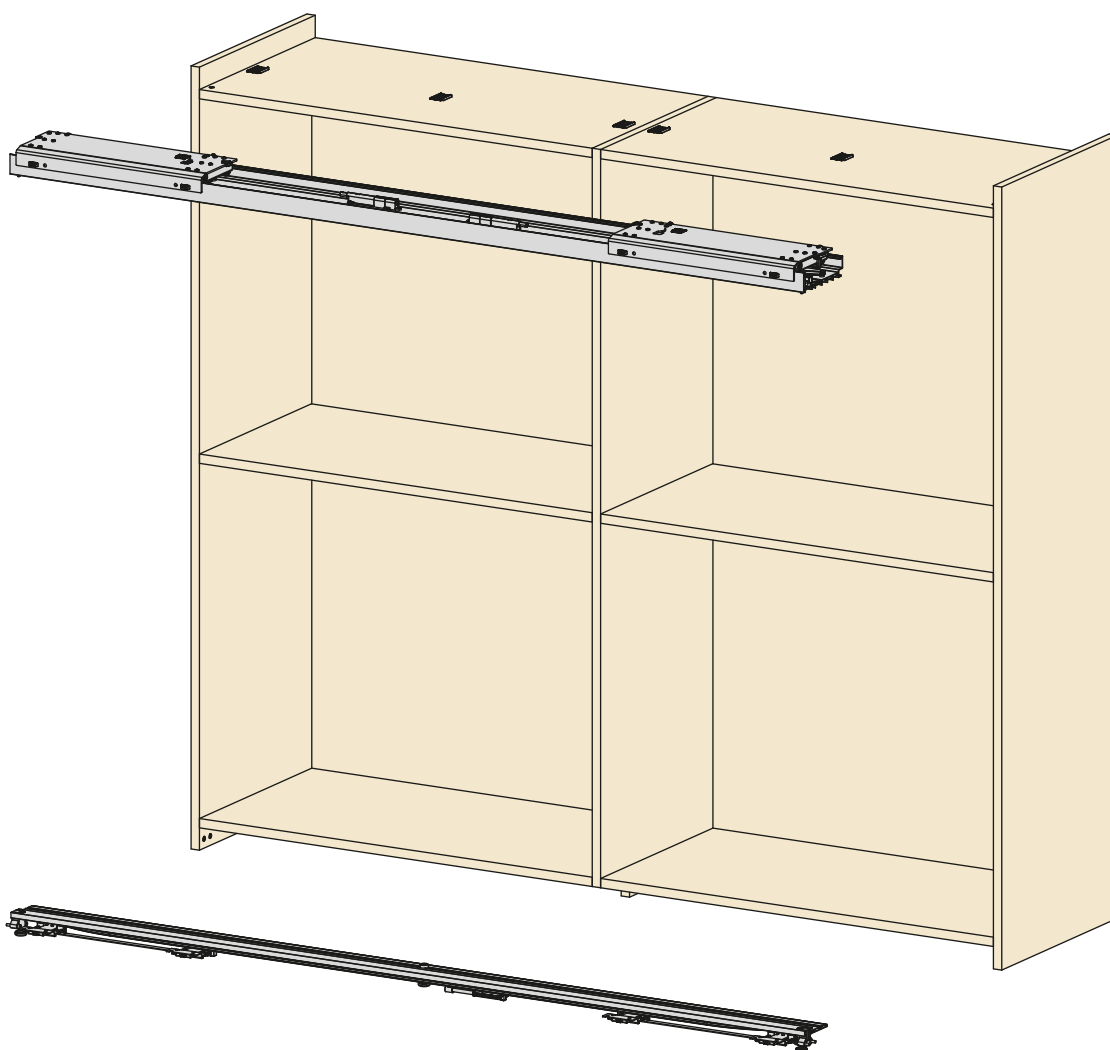

Principais características

- Amortecedor com tecnologia magnética.
- Máxima simplicidade de montagem.
- Absoluta fluidez no deslizamento com amortecedor na abertura e no fechamento.
- Elevada confiabilidade, comprovada com teste de 100.000 ciclos.

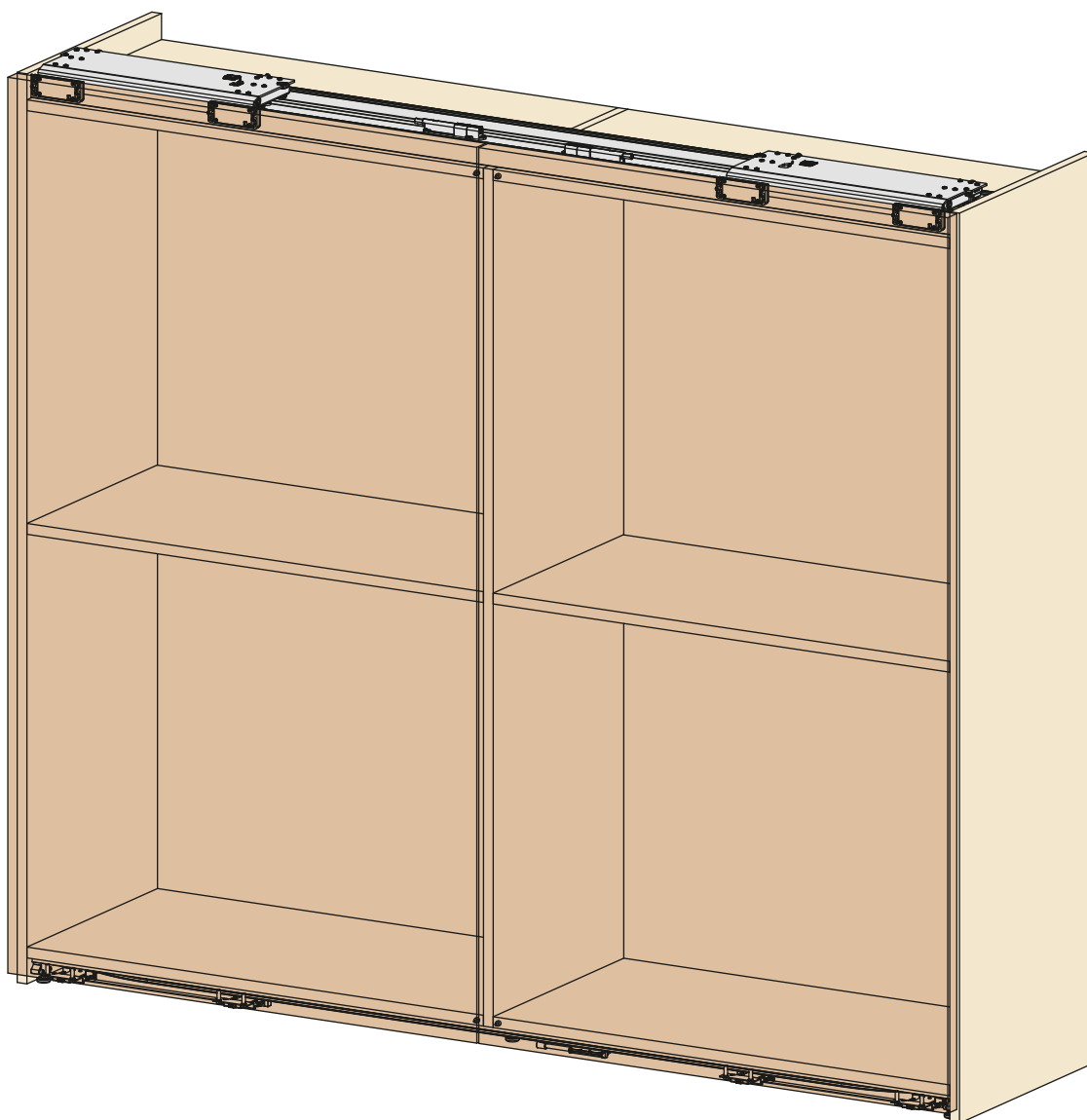

Slider M50 - Tipos de montagem

17 (M50)

Grupos de regulagens externos

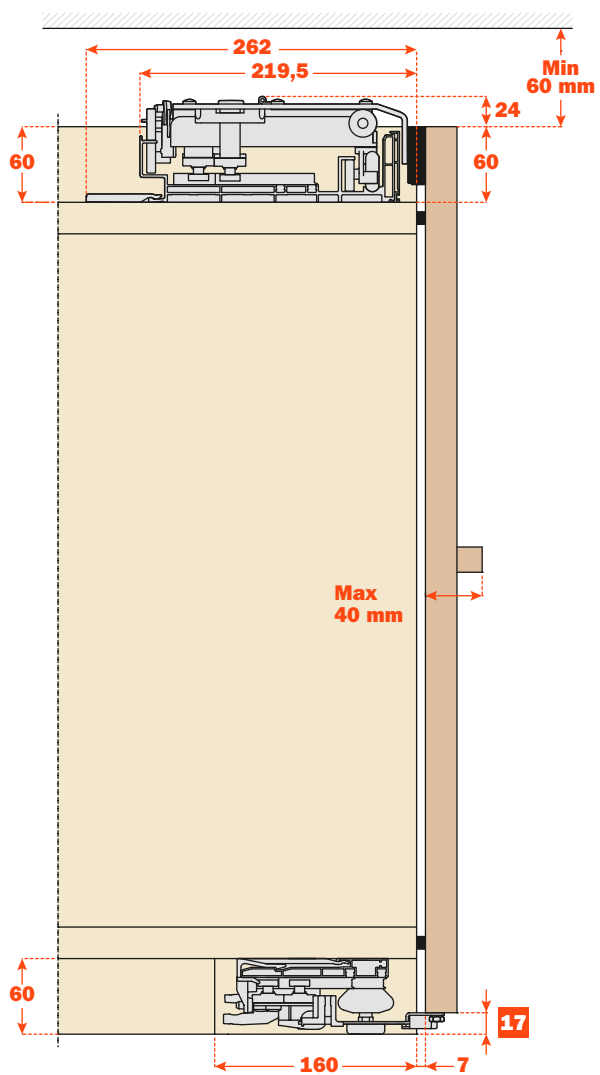

17 (M50)

Grupos de regulagens embutidos

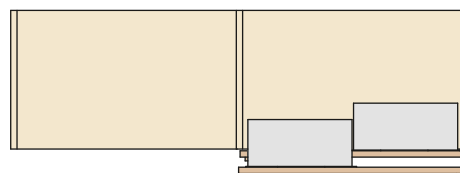
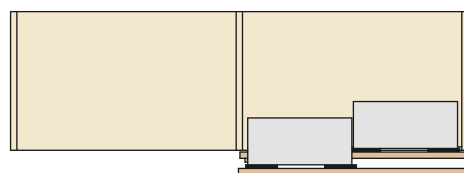
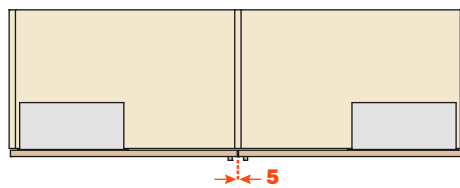
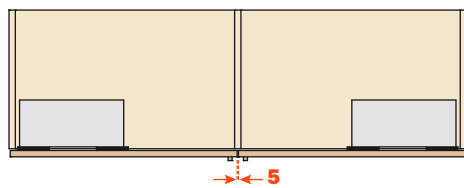
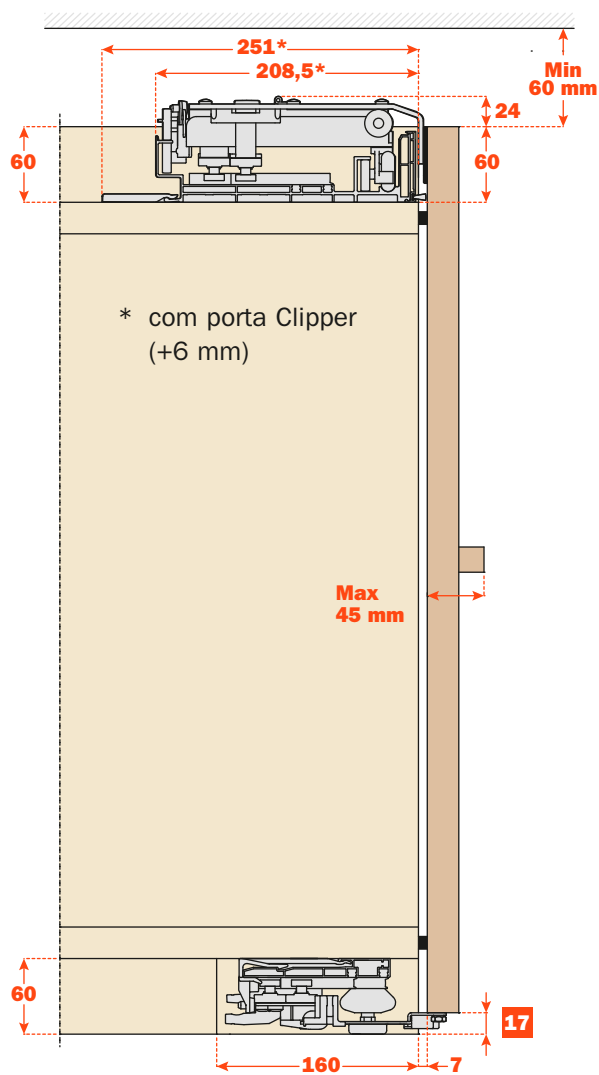

33 (M50)

Grupos de regulagens externos

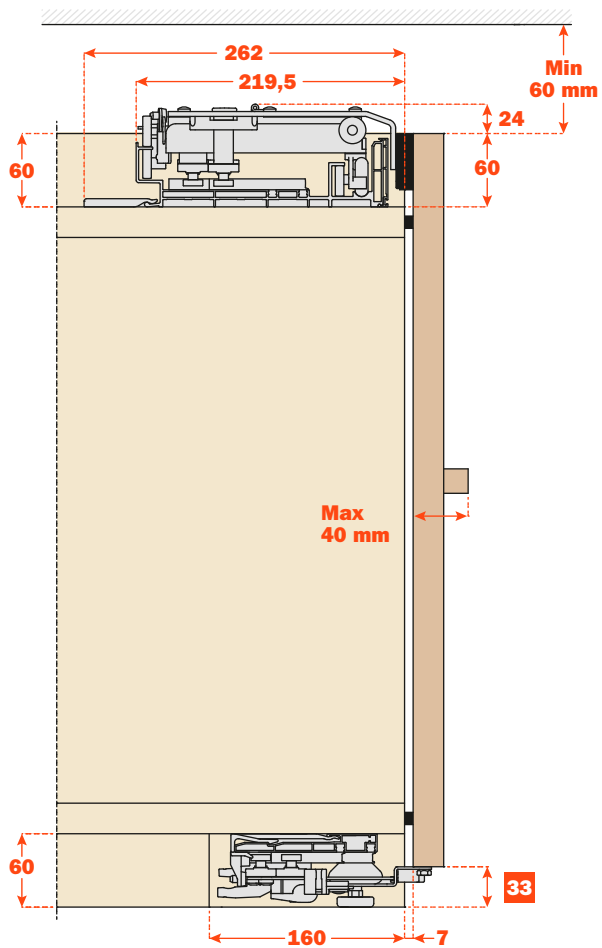

33 (M50)

Grupos de regulagens embutidos

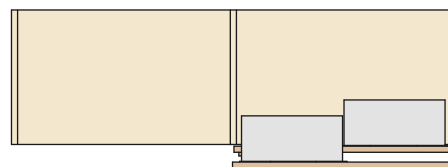
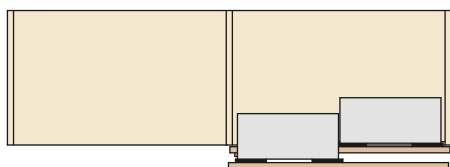
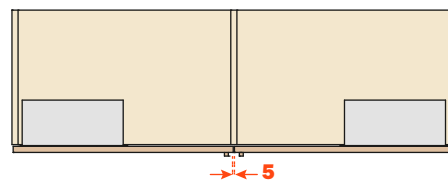
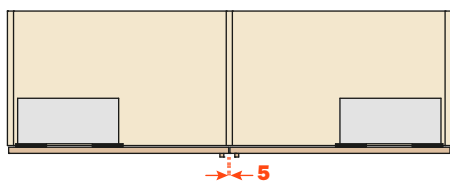
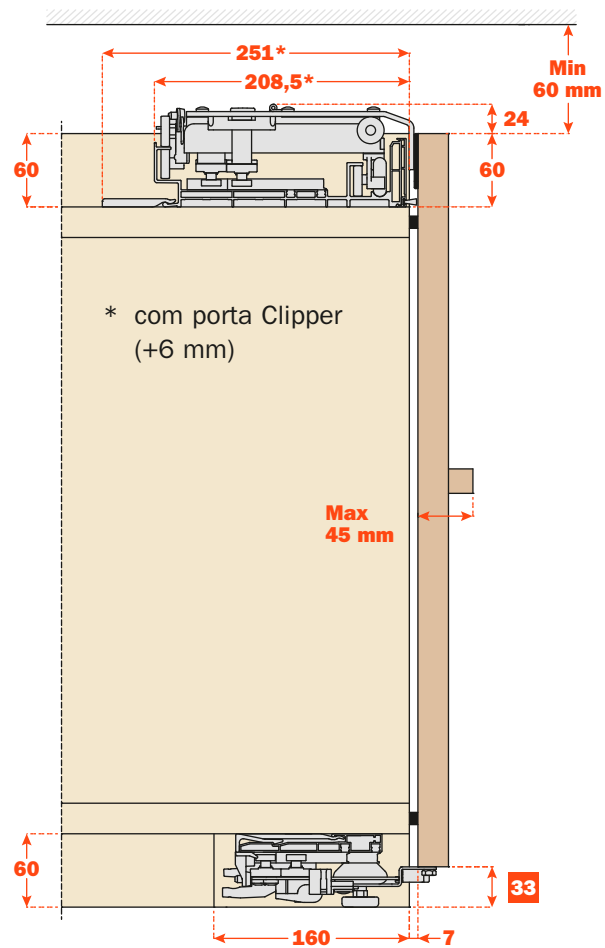

Slider M50 - Como pedir o M50

Sob medida

Os mecanismos Slider M50 podem ser solicitados “sob medida”, ou seja projetados para serem instalados em móveis com largura interna (**LI**) igual ao comprimento dos trilhos (**CP**).

Atenção: a abertura das portas pode ser decidida pelo cliente graças à variável **RAA** (distância entre a lateral central e a borda da porta).

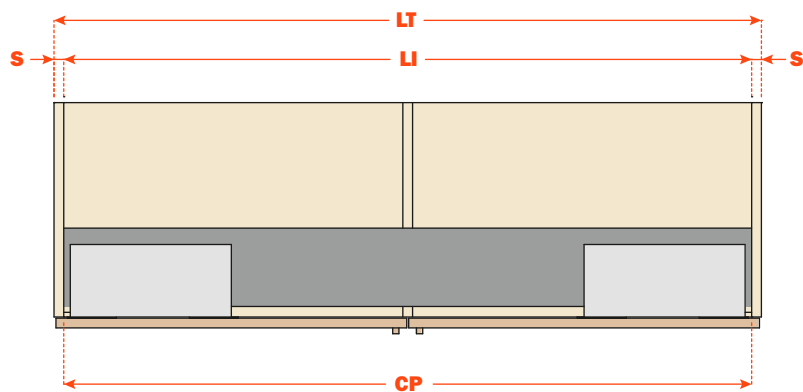

$$LI = LT - 2 * S$$

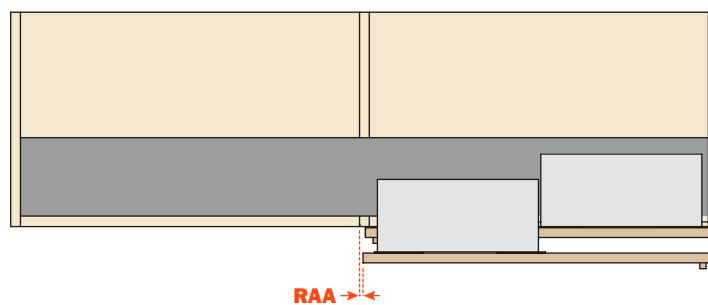

Como pedir

Standard

Os mecanismos Slider M50 podem ser “standard”, ou seja, projetados para serem instalados em móveis com medida interna (**LI**) até 200 mm maior do que o comprimento dos trilhos (**CP**) (Fig. **A**).

Atenção: a abertura das portas poderá ser reduzida (ver fórmula Fig. **B**).

Fig. **A**

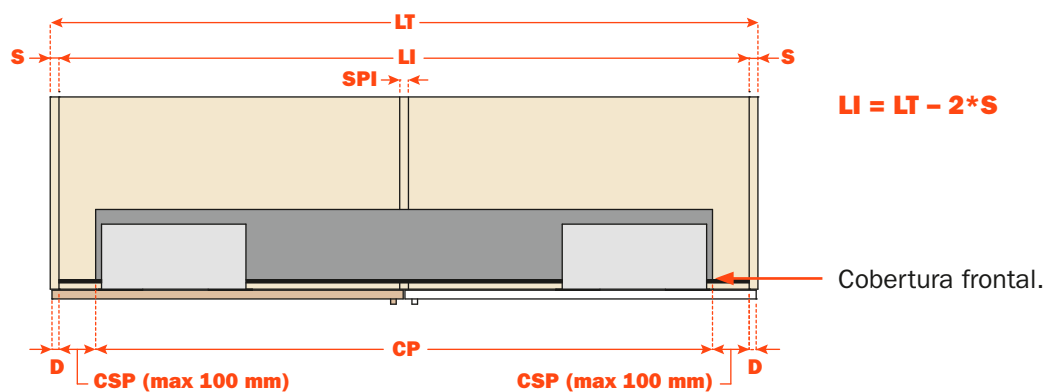
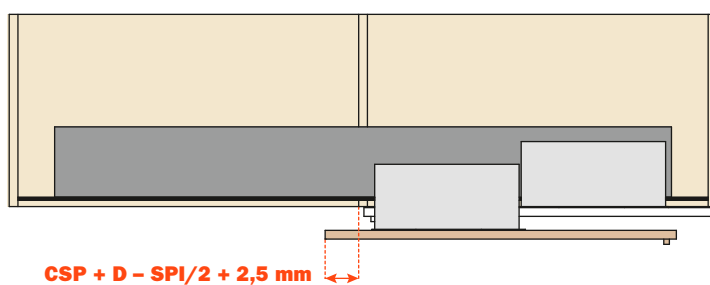
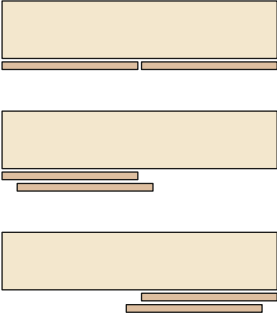

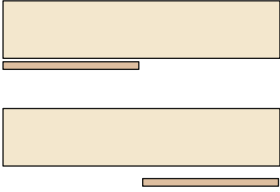

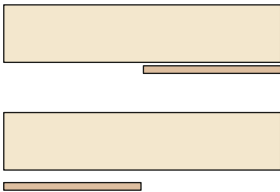

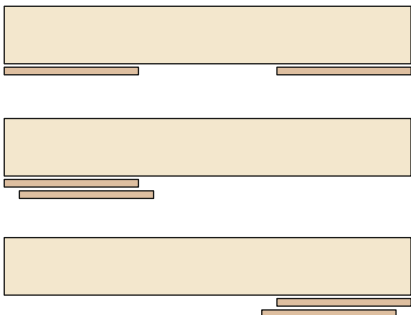

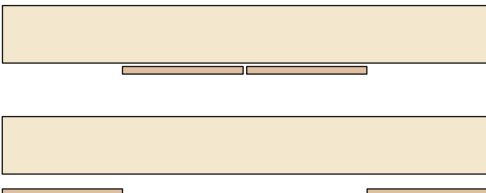



Fig. **B**



Descrição	Códigos	LI (mm)	CP (mm)	
Slider M50 2 portas	SM16-18	VE51FB01600NN	1600÷1799	1599
	SM18-20	VE51FB01800NN	1800÷1999	1799
	SM20-22	VE51FB02000NN	2000÷2199	1999
	SM22-24	VE51FB02200NN	2200÷2399	2199
	SM24-26	VE51FB02400NN	2400÷2599	2399
	SM26-28	VE51FB02600NN	2600÷2799	2599
	SM28-30	VE51FB02800NN	2800÷2999	2799
	SM30-32	VE51FB03000NN	3000÷3199	2999
	SM32-34	VE51FB03200NN	3200÷3399	3199
	SM34-36	VE51FB03400NN	3400÷3599	3399
	SM36-38	VE51FB03600NN	3600÷3799	3599
	SM38-40	VE51FB03800NN	3800÷3999	3799

Slider M35 - M50 - Versões disponíveis

<p>Standard</p>		<p>Slider M35 Slider M50</p>	 <p>Slider M35</p>
<p>One</p>		<p>Slider M35 Slider M50</p>	 <p>Slider M35</p>
<p>One</p>		<p>Slider M35 Slider M50</p>	 <p>Slider M35</p>
<p>Step</p>		<p>Slider M35 Slider M50</p>	 <p>Slider M35</p>
<p>Reverso</p>		<p>Slider M35 Slider M50</p>	 <p>Slider M35</p>

ARTURO SALICE S.p.A.

VIA PROVINCIALE NOVEDRATESE, 10
22060 NOVEDRATE (COMO) ITALIA
TEL. 031 790424 - FAX 031 791508
info.salice@salice.com - www.salice.com

DEUTSCHE SALICE GMBH

RUDOLF DIESEL STR. 10
74382 NECKARWESTHEIM
TEL. 07133 9807-0
FAX. 07133 9807-16
info.salice@deutschesalice.de
www.salice.com

DEUTSCHE SALICE GMBH

VERKAUFSBÜRO NORD
RINGSTRASSE 36/A30 CENTER
32584 LÖHNE
TEL. 05731 15608-0
FAX. 05731 15608-10
vknord@deutschesalice.de
www.salice.com

SALICE UK LTD.

KINGFISHER WAY
HINCHINGBROOKE BUSINESS PARK
HUNTINGDON CAMBS PE 29 6FN
TEL. 01480 413831
FAX. 01480 451489
info.salice@saliceuk.co.uk
www.salice.com

BORTOLUZZI SISTEMI S.p.A.

VIA CADUTI 14 SETTEMBRE 1944, 45
32100 BELLUNO ITALIA
TEL. 0437 930866 - FAX 0437 931442
info@bortoluzzi.com - www.bortoluzzi.com

SALICE FRANCE S.A.R.L.

285 RUE DE GOA ZAC LES 3 MOULINS
06600 ANTIBES
TEL. 0493 330069
FAX. 0493 330141
info.salice@salicefrance.com
www.salice.com

SALICE ESPAÑA, S.L.U.

C/ AIGUAFREDA 4, P.I. AMETLLA PARK
08480 L'AMETLLA DEL VALLÈS (BARCELONA)
TEL. 00351 938 46 88 61
info.salice@saliceespana.es
www.salice.com

SALICE PORTUGAL UNIP. LDA

SHOWROOM:

TV SÁ E MELO 161 FA
4470-116 MAIA - PORTO
TEL: 00351 224 154 221
Info@saliceportugal.pt
www.salice.com

ARMAZÉM:

VIA ROTA DOS MÓVEIS I 399
4585-325 GANDRA

SALICE CHINA (SHANGHAI) CO. LTD.

1st FLOOR, B1 BLDG 928 MINGZHU ROAD
XUJING, QINGPU DISTRICT
SHANGHAI 201702 - CHINA
TEL. 021 3988 9880
FAX. 021 3988 9882
info.salice@salicechina.com
www.salicechina.com

SALICE INDIA PVT. LTD.

1001 & 1002, 10TH FLOOR,
CENTRUM, PLOT NO. C-3,
OPP. WAGLE PRABHAG SAMITI OFFICE,
MIDC AREA, WAGLE INDUSTRIAL ESTATE,
THANE - 400604, MAHARASHTRA
TEL. 022 20812050
info@saliceindia.com
www.salice.com

SALICE CANADA INC.

3500 RIDGEWAY DRIVE,
UNIT#1
MISSISSAUGA, ONTARIO, L5L 0B4
TEL. 905 820 8787
FAX. 905 820 7226
info.salice@salicecanada.com
www.salicecanada.com

SALICE AMERICA INC.

2123 CROWN CENTRE DRIVE
CHARLOTTE NC. 28227
TEL. 704 841 7810
FAX. 704 841 7808
info.salice@saliceamerica.com
www.saliceamerica.com



Conteúdo digital

Reservamo-nos o direito de modificar as especificações técnicas.



DOCASS011POR Ed. 03 - 11/2023